

LE CUBE[®]

VERTICAL VIBRATING DESTEMMER

PATENT N° 0958477

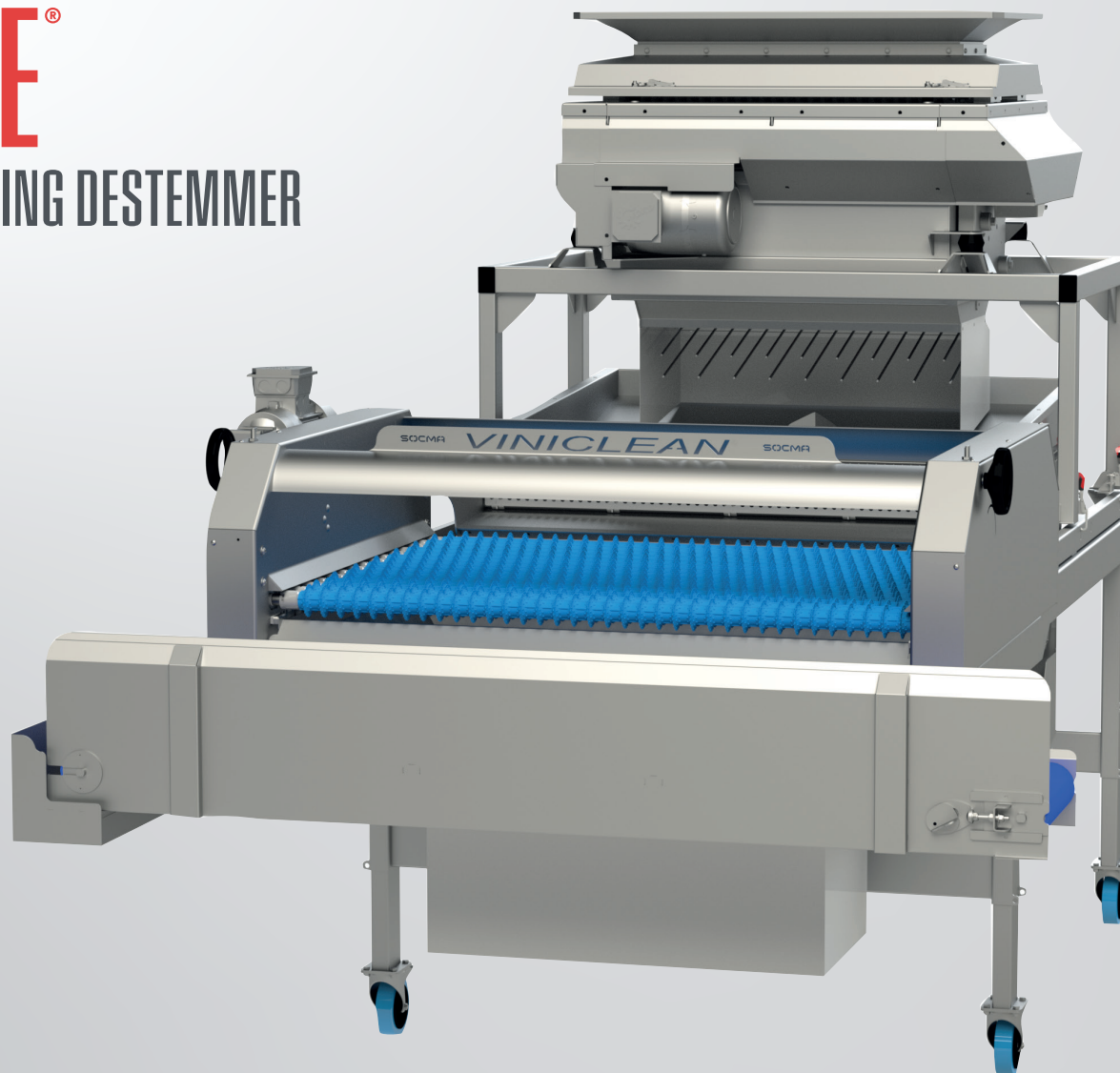

MADE IN FRANCE

SOCMA[®]

grapeworks NZ

LE CUBE®

Le Cube is a comprehensive tool with a gentle process which combines unequalled treatment of the grapes, simplicity of use, efficiency and ease of cleaning.

The solution for your harvest reception

Le Cube® is the most complete and versatile destemming and sorting device on the market. Due to its innovative design, it can be adapted to any configuration or need.

It can be fed by a bin or screw hopper, vibrating bin or hopper, belt or vibrating sorting table, conveyor belt, or by crate, with a manual harvest or mechanical harvest, to destem and sort, or to sort only.

TECHNICAL INFORMATION

Manual harvest throughput (depending on variety and maturity)	9 metric tonnes per hour
Mechanical harvest throughput (depending on variety and maturity)	15 metric tonnes per hour
Electrical power consumption	3,2 kw
Power supply	3 P+T
Electrical voltage	380 V
Minimum height	1.800 m
Length	2.730 m
Width	1.936 m
Weight	650 kg

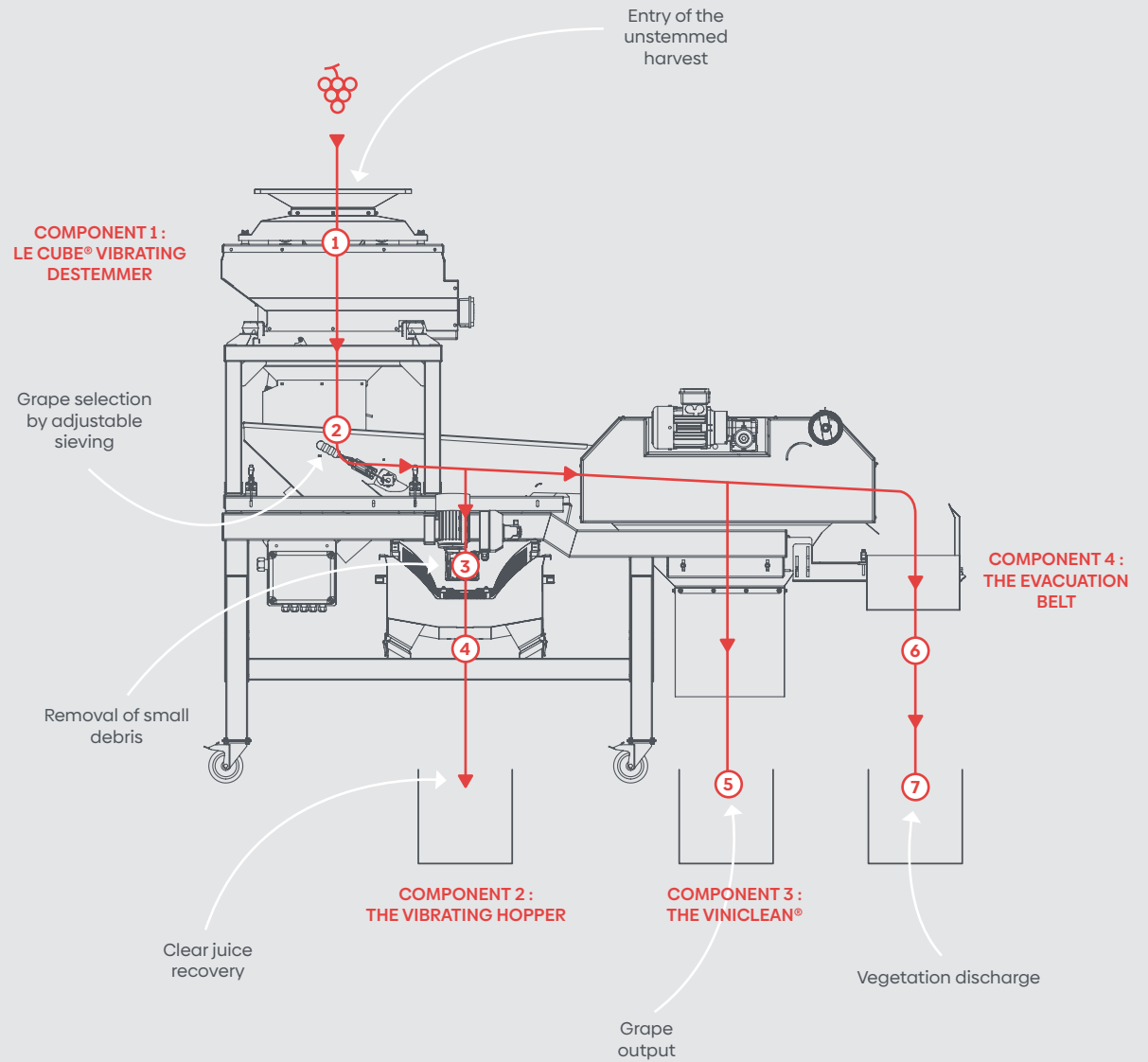

COMPONENT N°1

THE VIBRATING DESTEMMER

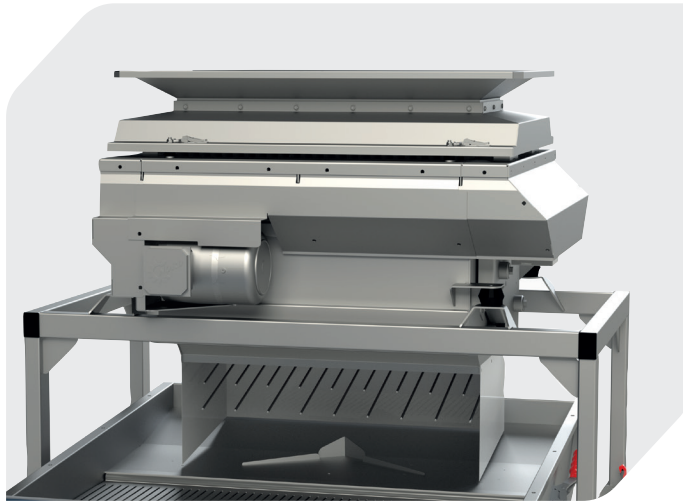
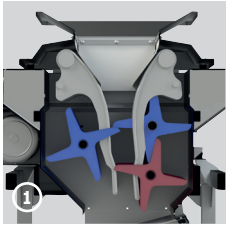
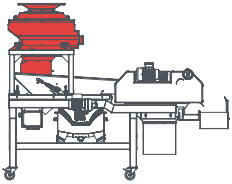

This system, which is unique on the market, allows for a gentle and silent destemming of the harvest by removing the grapes from the stems without the slightest of trauma to the components of the cluster. It consists of two rows of plastic destemming fingers which form a vertical vibrating corridor in which the clusters are guided (1).

The detached grapes descend naturally by gravity and the stems are carried downwards by flexible discs. This phenomenon of gravitational destemming gives Le Cube its ability to preserve the integrity of the grapes, but also, thanks to its design using flexible materials, it can handle foreign matter, such as pieces of stumps or stakes, taken in during mechanical harvesting without causing damage or jamming.

COMPONENT N°2

THE VIBRATING HOPPER

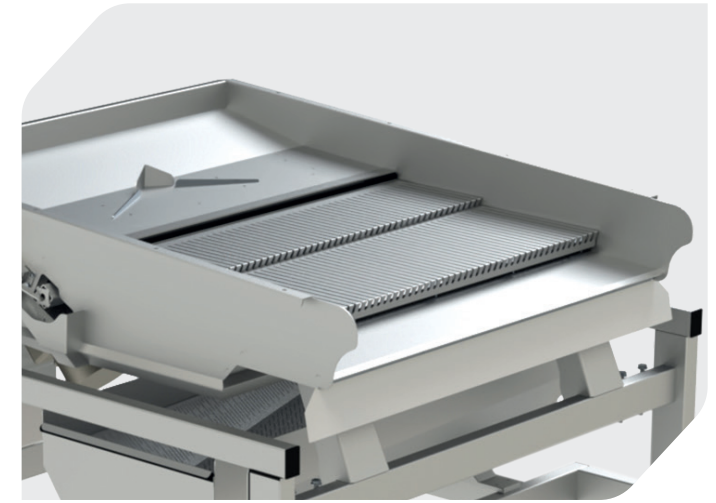
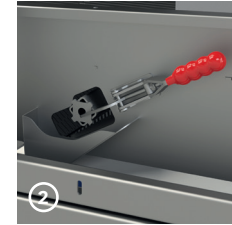
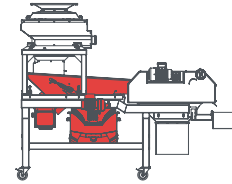

The vibrating hopper offers various benefits. The first is to control the accuracy of the adjustments made to the destemming head. The second is to distribute the harvest evenly over the entire surface of its grid in order to effectively sift out the juice and any small unwanted debris. The third is to orientate the flow of matter horizontally in order to facilitate and optimise the work of the Viniclean rollers.

This vibrating component, which is 1100mm wide, is equipped with a grid that can be dismantled instantly and without the need for tools (2) making it possible to adapt the opening of the grid (3mm, 5mm or 7mm) to the size of the grape variety to be treated or to the small debris to be eliminated (green berries, dry or undeveloped berries, small snails). Under the grid is a bin, fitted with a 50mm mason coupling containing a sieve (or optionally an automatic waste evacuation screw) which separates the solid waste from the liquid (3).

COMPONENT N°3

THE VINICLEAN®

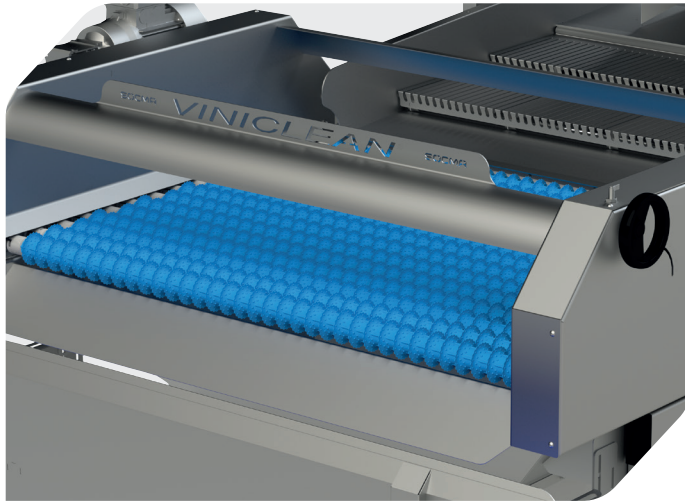
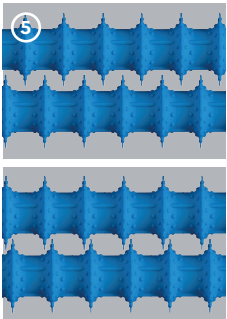
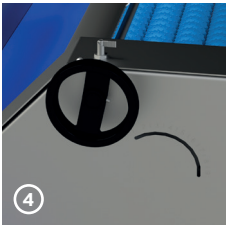
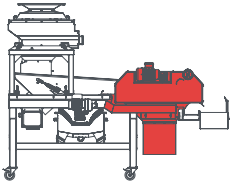

This 15-roller sorting tool, equipped with flexible plastic sleeves with adjustable spacing on two axis, allows for the precise extraction of vegetation and any other debris larger than the grape berry (stems, petioles, leaves, snails, pieces of stump, etc.).

The contours and the soft material of our sorting rollers have been specially designed by our engineering department for optimal plant grip without crushing the fruit.

The instantaneous adjustment of the roller spacing (4) combined with the possibility of a lateral spacing adjustment of the sleeve contours (5) ensures a precise calibration adapted to all types of grape varieties.

COMPONENT N°4

THE EVACUATION BELT

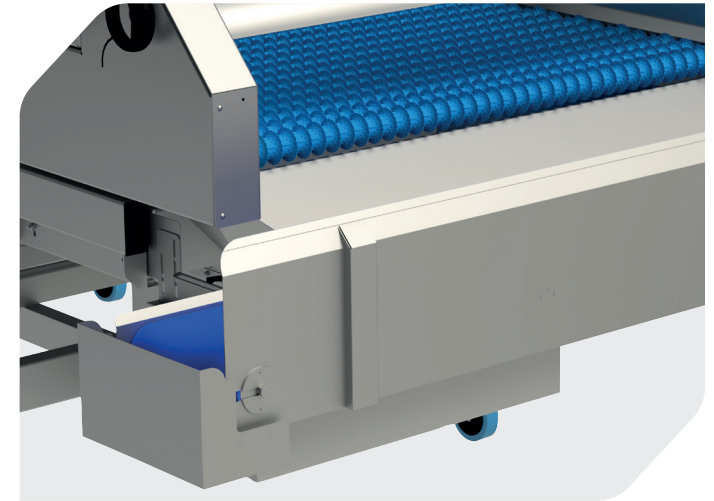
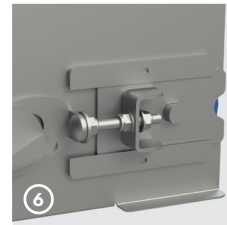
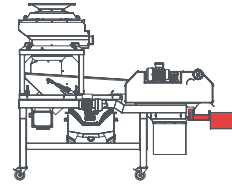

The evacuation of debris is a common problem that we have solved with this two-way rotating belt.

By reversing the direction of rotation it is now possible to position a waste bin on either side of the conveyor belt so that, while reversed, the full bin can be emptied on one side while the other is filled on the opposite side.

This waste conveyor belt is equipped with a drum motor, a 300mm wide cleated belt and a tensioning system for fast and accurate cleaning (6).

OPTIONAL EQUIPMENT

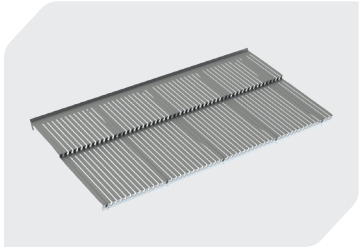

STAINLESS STEEL HOPPER GRID

Additional stainless steel vibrating hopper grid for Viniclean® Eco and TER.

- ▶ Available with 3mm, 5mm or 7mm openings

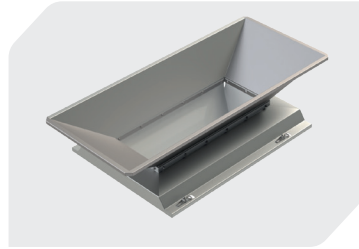

WIDE HOPPER

Enlarged intake hopper for feeding by bin or by a vibrating spout hopper.

- ▶ W: 1300mm
- ▶ D: 530mm
- ▶ H: 294mm
- ▶ For unloading containers with a vibrating chute

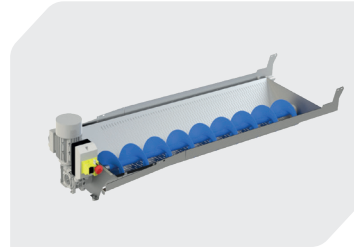

EVACUATION SCREW

Automatic waste evacuation screw located under the vibrating hopper grid. This option replaces the drip trough above the juice tank which needs to be cleaned regularly.

- ▶ Flexible worm screw with geared motor and electrical connection
- ▶ Perforated and microblasted stainless steel trough

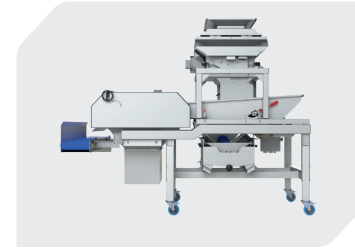

SLIDING LE CUBE

This option allows the destemmer head to be retracted so that only the sorting system is used (destemmed mechanical harvest).

- ▶ Destemmer mounted on a chassis equipped with rollers and stainless steel rails with a locking latch allowing the harvest to be discharged directly onto the vibrating hopper
- ▶ Up to 600mm forward travel

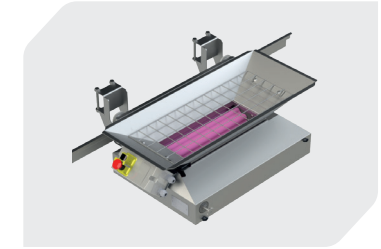

REMOVABLE CRUSHER

This option allows the Socma crusher to be mounted at an optimal height. The crusher can also be mounted on a mobile chassis, which takes up slightly more space but is much more practical.

- ▶ Large crusher mounted on a stainless steel chassis
- ▶ Three positions: active, retracted, dismantled (tool-less)

Simplified cleaning thanks to
the tool-less disassembly of
the various components of
Le Cube®.

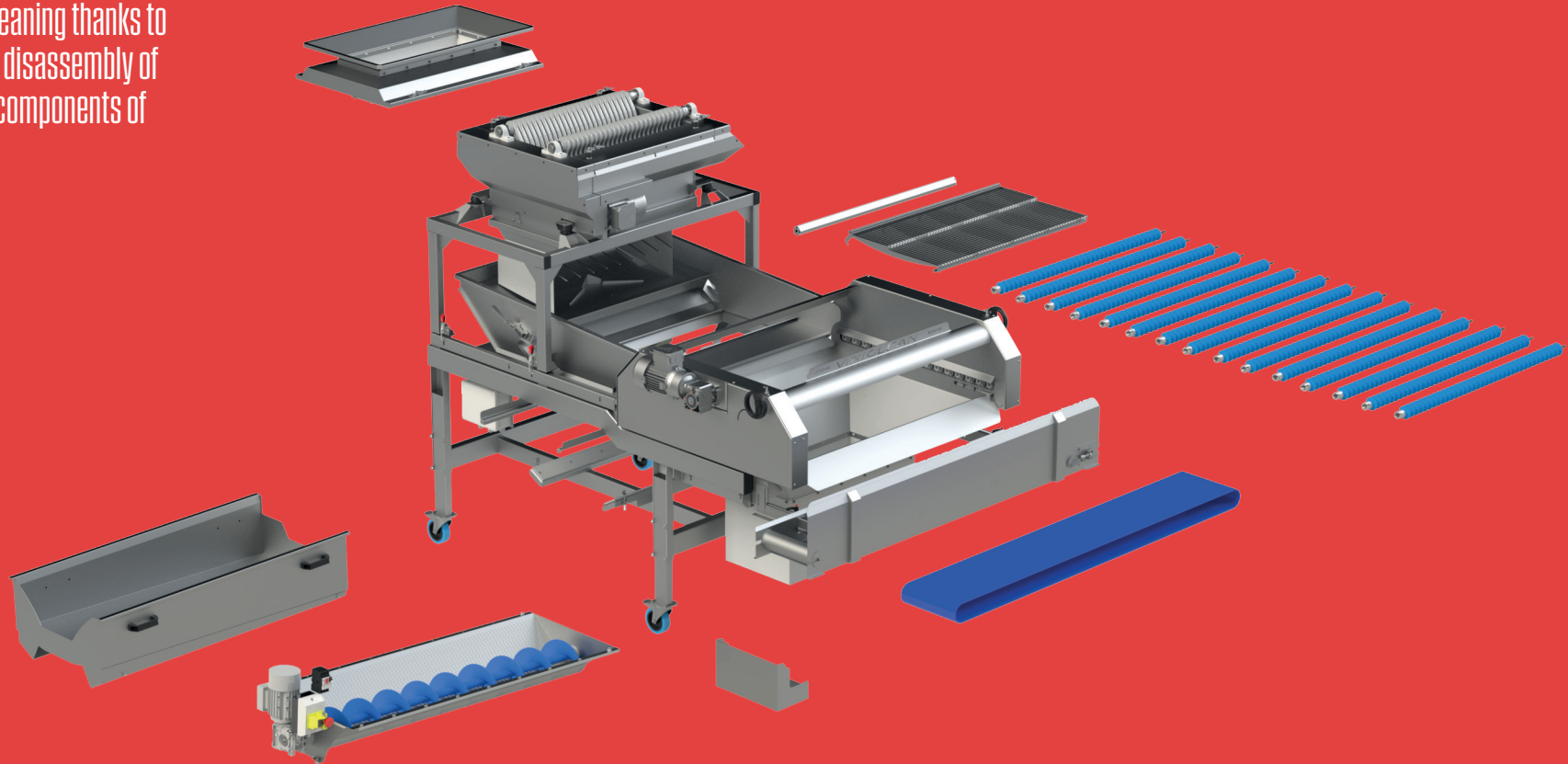

SOCMA®

Contact 04 390 3577 for more information
or email on info@grapeworks.co.nz

grapeworks NZ